

EVOLUTION BUILDING ACCESS CONTROL SYSTEM



BY CS TECHNOLOGIES

EVOLUTION

Smarter, Easier, Modular, Flexible, Cost Effective. And most importantly Easy to Use.

3RD GENERATION CONTROLLER

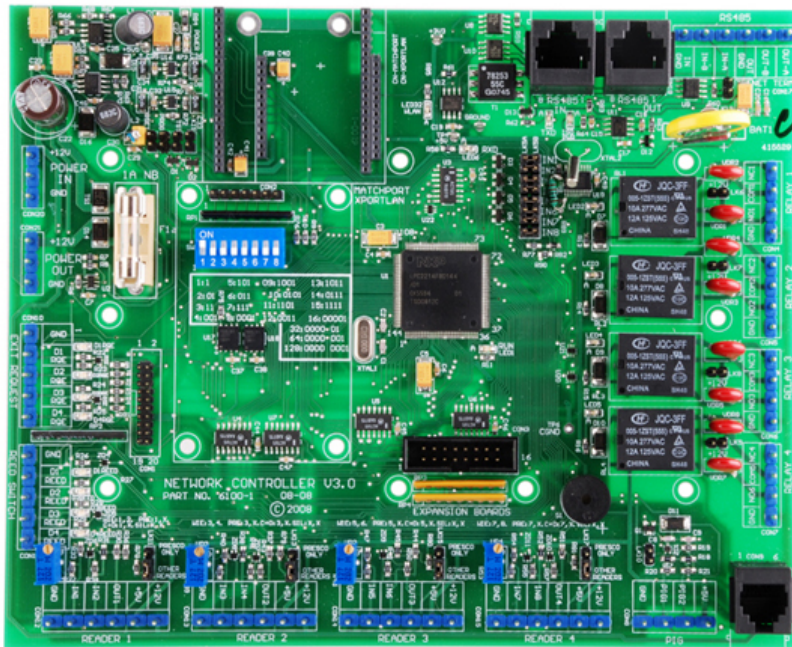

- Latest 32bit ARM Microcontroller
- Fully Independent Control.
- Modular System Design
- Cost Effective 2 and 4 Door Versions.
- IP and RS485 Communication Support.
- 20+ Years of Development.
- Firmware Upgradable
- Australian Designed and Manufactured

EVOLUTiON

Smarter, Easier, Modular, Flexible, Cost Effective. And most importantly Easy to Use.

5TH GENERATION MANAGEMENT SOFTWARE

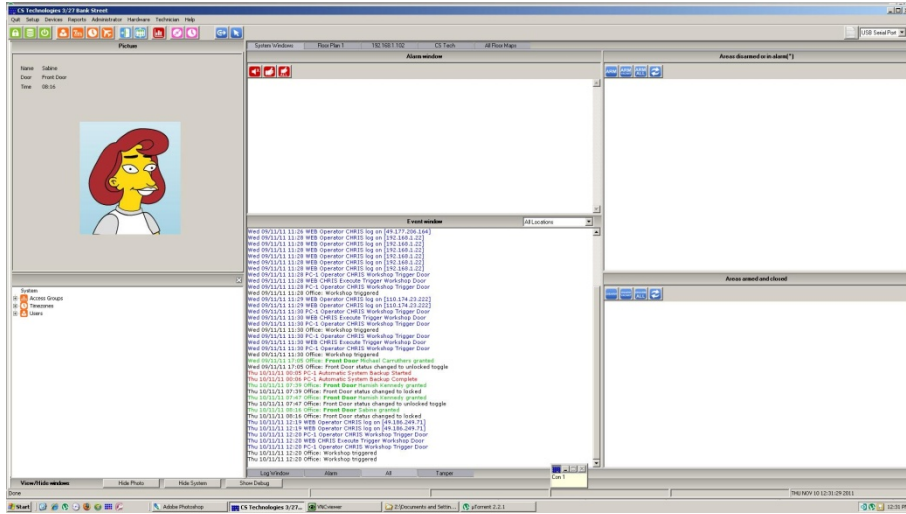

- FREE Evolution Software.
- No Installer Fee. No Add-on Fees.
- Windows 8 (64bit) Compatible
- “The Most User Friendly Software in the Industry”.
- Manage 100s of Sites, any where in the world. (Remote of Local Database)

EVOLUTiON

Smarter, Easier, Modular, Flexible, Cost Effective. And most importantly Easy to Use.



CONTROL DOORS, LIFTS, ALARMS...



Manage and Control:

- Doors
- Lifts (Lift Banks for easy programming)
- Lighting
- Air Conditioning
- Parking Groups
- Anti-pass back (& Muster Reports)
- CCTV / DVR Cameras
- Alarms
- Almost anything

EVOLUTiON

Smarter, Easier, Modular, Flexible, Cost Effective. And most importantly Easy to Use.



CONTROL DOORS, LIFTS, ALARMS...



Manage and Control:

- Add / Delete Users
- Configure Access Groups for Doors, Lifts and Areas
- Generate History Reports
- Daylight Savings
- Holiday Programming
- User Expiry Date and Time
- Time and Attendance
- Integrate with other applications

EVOLUTION

Smarter, Easier, Modular, Flexible, Cost Effective. And most importantly Easy to Use.

COMPATIBLE WITH MOST READER TECHNOLOGIES



- Proximity and Smart Cards
- PIN Numbers
- Silicon Keys
- Biometric
 - Finger Print
 - Iris etc.
- RF (Remote Transmitters)

EVOLUTiON

Smarter, Easier, Modular, Flexible, Cost Effective. And most importantly Easy to Use.



CONTROL LIFTS...

Lift Control:

- Low Level Interface
- High Level Interface
 - OTIS Compass HLI
 - Kone HLI
- Control up to 255 floors per lift
- Lifts are Grouped in Lift Banks to make user programming easier.
- Floor Destination Reporting
- Floor Button Presence
 - Prevent Elevator Tailgating

EVOLUTION

Smarter, Easier, Modular, Flexible, Cost Effective. And most importantly Easy to Use.

CONTROL ALARMS...

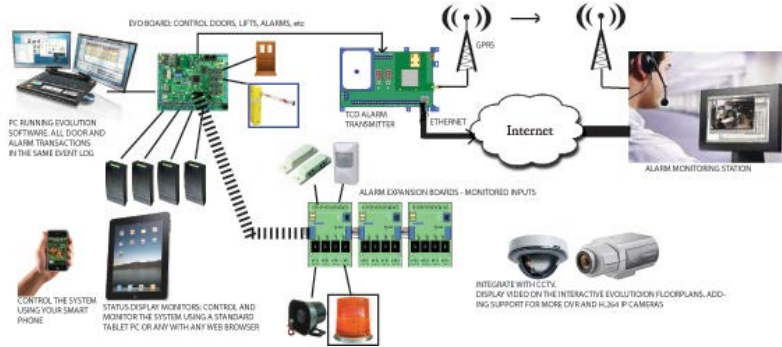

Alarm Control:

- Integrated Door Access with Alarms
 - Prevent door access if Area Armed.
 - Open the Door and Disarm Area.
 - 3 Card Badge to Arm the Alarm.
- Back to Base Alarm Signals
 - Dual Path: Ethernet & GPRS
- End or Line Tamper Input Monitoring



EVOLUTION

Smarter, Easier, Modular, Flexible, Cost Effective. And most importantly Easy to Use.

SYSTEM EXPANSION

Expansion of the Evolution System with input and output (relay) is cost effective.

- 128 Controllers Per Site (Unlimited number of sites per System).
- Expand each controller up to
 - 255 input
 - and 255 relays.
- 4 and 16 Relay Expansion Boards
- 2, 12 and 16 Input Expansion Boards

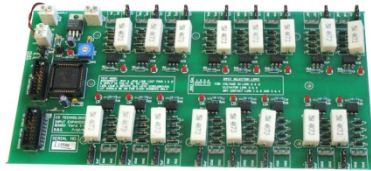
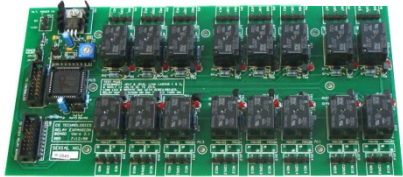
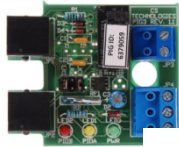
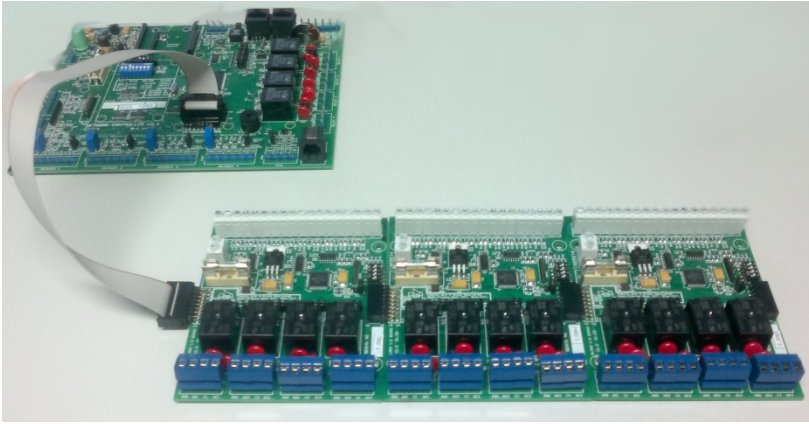

EVOLUTiON

Smarter, Easier, Modular, Flexible, Cost Effective. And most importantly Easy to Use.

CONTROL ALL YOUR SITES LOCALLY

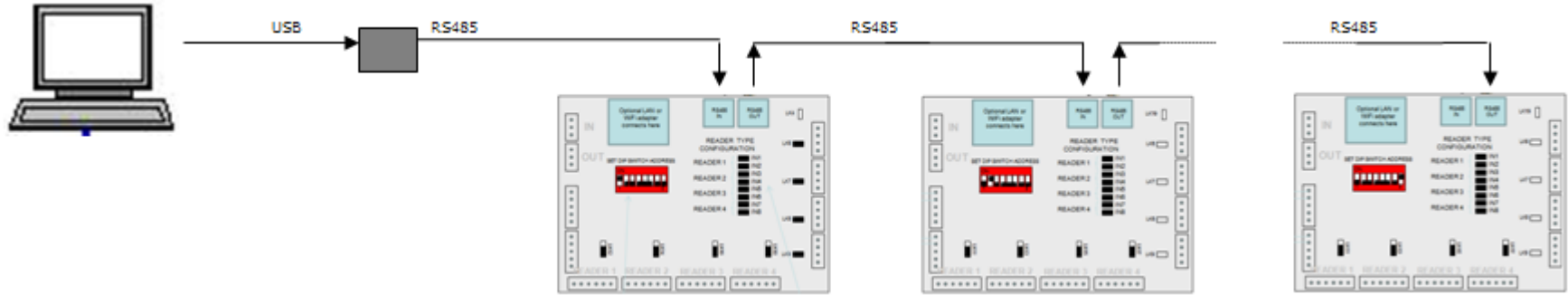

- Manage 100s of Sites and Location Databases Locally or Globally.
- Local or Remote Database

- Remote and Local Site Control
 - TCP/IP Connection
- Install Multiple Workstations.

EVOLUTION

Smarter, Easier, Modular, Flexible, Cost Effective. And most importantly Easy to Use.

OR FROM ANYWHERE IN THE WORLD

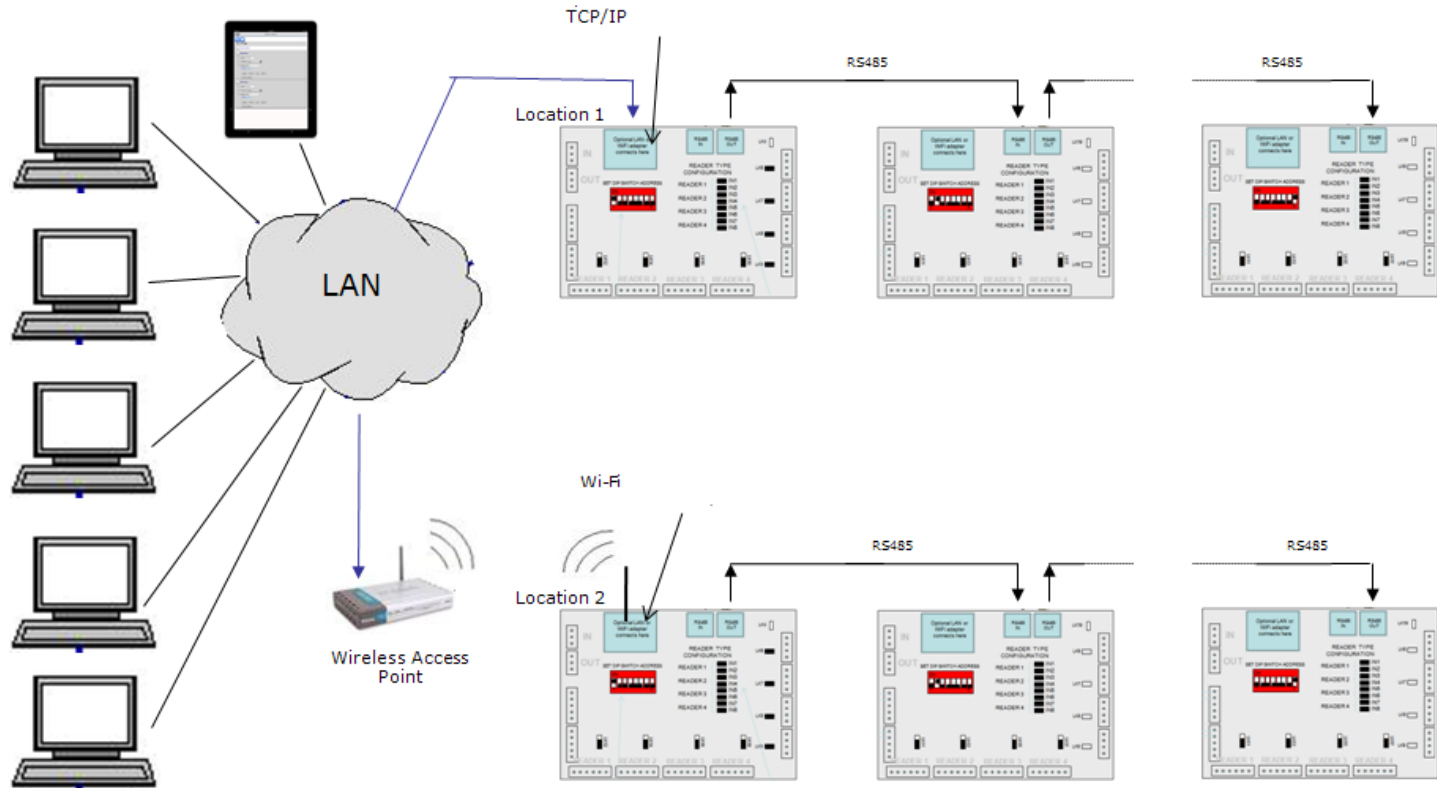

EVOLUTION

Smarter, Easier, Modular, Flexible, Cost Effective. And most importantly Easy to Use.

EVOLUTION SOFTWARE FEATURES



- Built in Web Interface. Control the software anywhere in the world via a standard web browser.
- Free iPhone and iPad Connection App



EVOLUTION

Smarter, Easier, Modular, Flexible, Cost Effective. And most importantly Easy to Use.

EVOLUTION SOFTWARE FEATURES



Alarm and Transactions Terminals

- Next Generation System Status Display. Eliminate the need for keypads.
- Touch Screen Control
 - iPad and Android Tablet Compatible.
- View Real Time System Event Logs
- Review Alarm and System Status
- Isolate Inputs
- Wi-Fi – no cabling required.

EVOLUTION

Smarter, Easier, Modular, Flexible, Cost Effective. And most importantly Easy to Use.

EVOLUTION SOFTWARE FEATURES



- Window 7 Touch Screen Compatible for easy to control and use Workstations

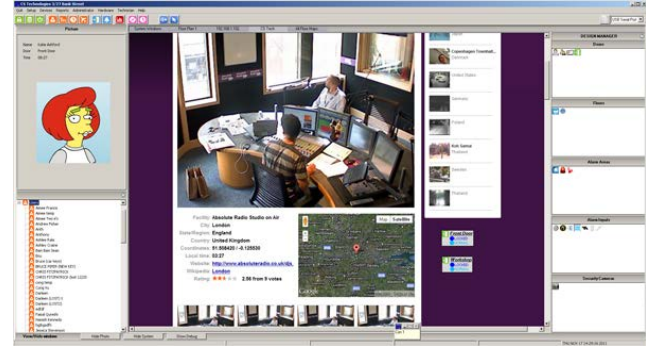

EVOLUTION

Smarter, Easier, Modular, Flexible, Cost Effective. And most importantly Easy to Use.

EVOLUTION SOFTWARE FEATURES



- Interactive Floor Plans
 - Live Door, Area, Input Status Display
 - Last User Use Information
 - h264 Video Display
 - Web Page Display
- Photo-ID Support
- More DVR Support being added.

EVOLUTION

Smarter, Easier, Modular, Flexible, Cost Effective. And most importantly Easy to Use.

EVOLUTION SOFTWARE FEATURES

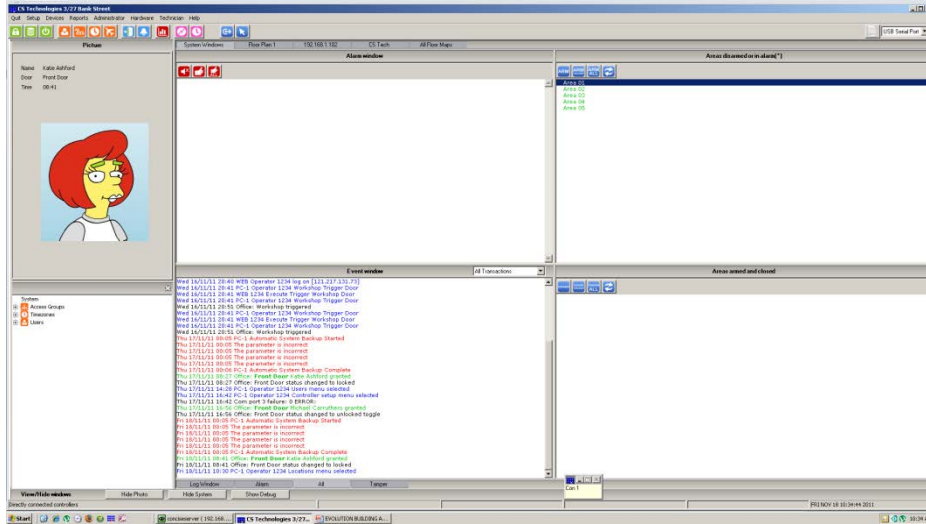

- Alarm Status and Control Window
 - Display Area Status
 - Display Area Input Status
- Control and Manage Areas
 - Isolate Inputs
 - Arm And Disarm

EVOLUTION

Smarter, Easier, Modular, Flexible, Cost Effective. And most importantly Easy to Use.

EVOLUTION SOFTWARE FEATURES



- Email Alarms
- Automatic Email Reports
 - Schedule Daily, Weekly, Monthly Automatic Reports.
- Check and Download for Software Updates
- .

EVOLUTION

Smarter, Easier, Modular, Flexible, Cost Effective. And most importantly Easy to Use.

EVOLUTION SOFTWARE FEATURES

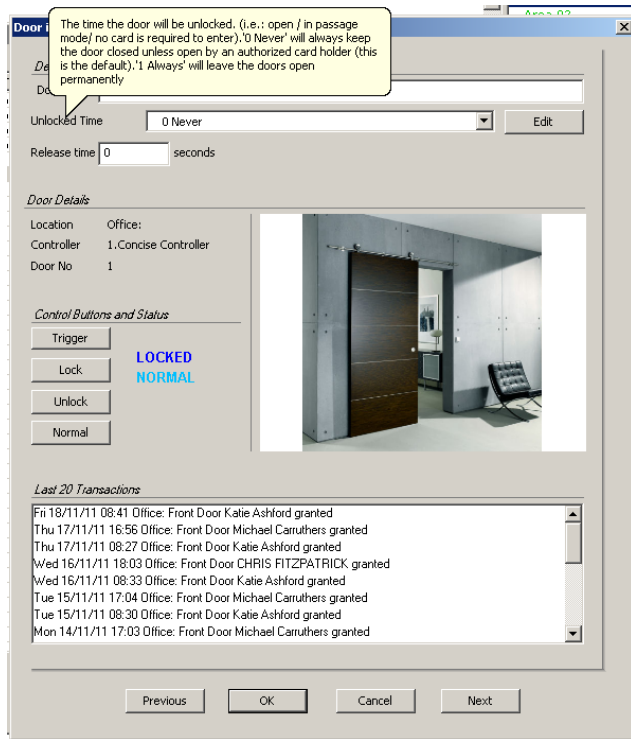

Plus many hidden features that make setting up and using the system easy.

- System Setup Wizard
- Bulk User Control
- Integrated Help
 - Highlight the software and the help information will appear on the same screen (no need to open the help file)

EVOLUTION

Smarter, Easier, Modular, Flexible, Cost Effective. And most importantly Easy to Use.

EVOLUTION SOFTWARE FEATURES

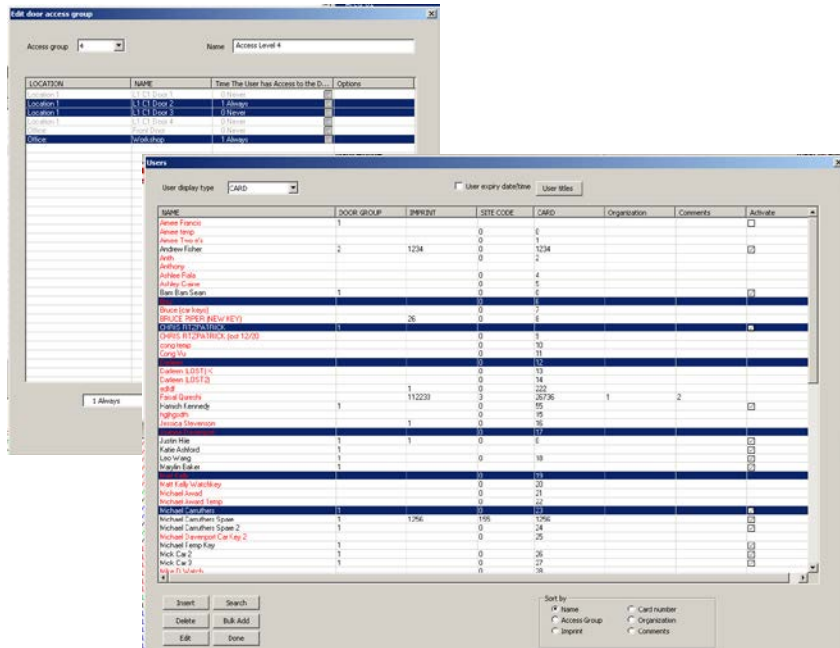

Plus many hidden features that make setting up and using the system easy.

- Auto Last Transactions Report when editing a user
- Automatically get daylight savings dates from PC.
- Bulk Access Group Door Editing
- Activate and Deactivate Users without Changing their Programming.

EVOLUTION

Smarter, Easier, Modular, Flexible, Cost Effective. And most importantly Easy to Use.

EVOLUTION - THE SMART CHOICE



Evolution.

The Smarter, Easier, Modular, Flexible,
Cost Effective And most importantly
Easy to Use Access Control and Alarm
Security Solution.

EVOLUTION

Smarter, Easier, Modular, Flexible, Cost Effective. And most importantly Easy to Use.

www.cstech.biz



End of Slide Show